



DeviceMaster® RTS VDC 1-Port

Part Number: 99440-4



KEY FEATURES AND BENEFITS

- No serial cable distance limitations enables communication between a host PC and serial devices located anywhere across an Ethernet network
- Software selectable RS-232/422/485 serial interfaces
- Supports native COM, TTY, or TCP/IP socket communication modes
- Web-based configuration makes setup and management changes quick and easy
- Real-time e-mail event notification alerts administrator of potential connection and security issues
- Wide operating temperature range (-37° to 74°C) for harsh environments
- Rugged stainless steel housing enables DIN rail or panel-mounting
- Variable power input eliminates need for power converters
- PortVision® DX monitoring and management software automatically monitors devices on the network and enables user to view status, update firmware and resolve issues remotely
- RoHS2 compliance under CE
- IPv6 support
- NEMA TS2 Certified

PRODUCT DESCRIPTION

The Control DeviceMaster RTS 1-Port VDC DB9 is a single-port device server designed for network-enabling serial communications devices. When used with the included NS-Link™ driver software and a host PC, the DeviceMaster RTS enables placement of COM or TTY ports anywhere on an Ethernet network or across the Internet. In applications where connecting legacy serial devices to a PC without software

changes is a requirement, a pair of DeviceMaster RTS units can be used to create a point-to-point serial tunnel across the network that seamlessly transfers serial data via TCP or UDP socket connections. DeviceMaster RTS VDC products are designed specifically for use where an existing power source from 5-30 VDC will be used.



DEVICEMASTER SPECIFICATIONS

HARDWARE

Serial Connectors	(1) DB9 Male
Ethernet Ports	(1) 10/100 BASE-T
Processor	ARM7 44Mhz
Memory	8MB RAM, 4MB Flash
Mounting	Panel/Rack, DIN rail
Product Dimensions	3.6" x 0.8" x 2.8" 9.14 x 2.03 x 7.11 cm
Product Weight	7.5 oz 212.62 g
LED Indicators	Status, Ethernet, Link/Activity, Collision, 100MB Ethernet, RX/TX Per Port
Housing	Rugged Steel Construction

NETWORK PROTOCOLS

Telnet, HTTP, SNMP, DHCP, RARP, ARP, BOOTP, Ping,
Supports IP multicast data transmission

SERIAL COMMUNICATIONS

Software-Selectable	RS-232/422/485
Baud Rates	50bps to 230 Kbps
Data Bits	7 or 8
Parity	Odd, Even, None
Stop Bits	1 or 2

FEATURES

Easy Set-up
Software-Selectable Serial Port Interface
PortVision Remote Management Software
PC-based or Web-based Serial Port Configuration
Watchdog Reset

ELECTRICAL SPECIFICATIONS

Device Requirements	5 to 30 VDC
Device Consumption	2.5 Watts
External Power Supply	Sold Separately
Surge Protection	15KV Per Port

ENVIRONMENTAL SPECIFICATIONS

Operating Temperature	-37° to 74°C
Storage Temperature	-40 to 85°C
Relative Humidity	5% to 95%
Altitude	0 to 10,000 Ft 0 to 3,048 m
Heat Output	8.5 BTU/Hr
Mean time between failures	46.2 Years

EXPORT INFORMATION

Packaged Shipping Weight	1.66lbs 0.75 kg
Package Shipping Dimensions	9.18" x 7.25" x 2.5" 23.32 x 18.42 x 6.35 cm
UPC Code	7-56727-99440-4
ECCN	5A992
Schedule B Number	8471.80.1000

REGULATORY STANDARDS

Immunity
EN55024, EN61000-4-2, EN61000-4-3,
EN61000-4-4, EN61000-4-5, EN61000-4-6,
EN61000-4-8, EN61000-4-11, IEC 1000-4-2,
IEC 1000-4-3, IEC 1000-4-4, IEC 1000-4-5,
IEC 1000-4-6, IEC 1000-4-8, IEC 1000-4-11

Emission
EN55022 & A1:2000 IEC 1000-3-2,
IEC 1000-3-3, CISPR-22, ICES-003

Safety
EN60950, IEC 60950,
CSA C22.2 No. 50/UL60950

Other
RoHS2 compliance under CE

REGULATORY APPROVAL MARKS



PIN ASSIGNMENTS

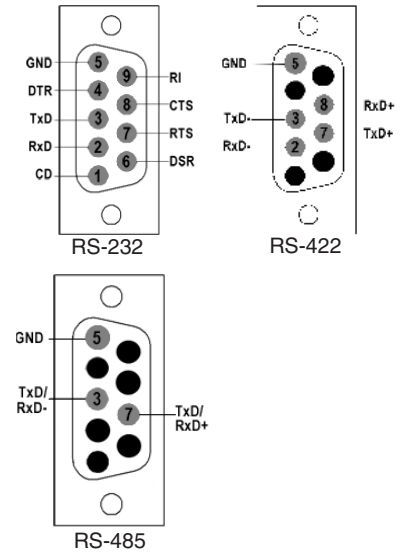

Warranty Information
Control offers a 30-day satisfaction guarantee and 5-year limited warranty.

Sales Support
+1.763.957.6000
sales@comtrol.com

Technical Support
+1.763.957.6000
www.comtrol.com/support

Email, FTP, and Web Support
info@comtrol.com
ftp.comtrol.com
www.comtrol.com